

tagawatt

Plug&Play submetering

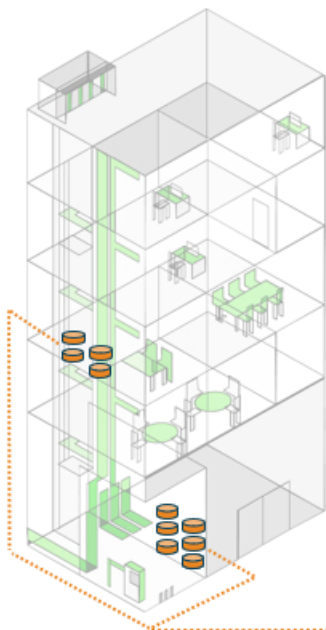

- Monitoring energy consumption
- Detecting reduction opportunities
- Controlling real savings

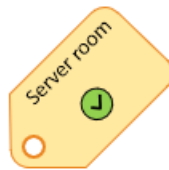

Plug&Play submetering



Plug&Play: Easy and fast, installed in 15 minutes instead of hours!



Accurate: Measures precisely the real (active) power every second



Universal: Compatible with all electrical installations



European: Designed and manufactured in France



Patented: multiple innovations protected by Patents

*A collection of innovations
simplifying the measurement and monitoring
of disaggregated energy consumption*

1. Tiny half-Rogowski PCBs => minimal size, no saturation

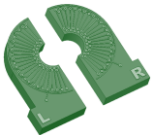

2. watTag: Current clamp that can open on the front (half-Rogows inside)

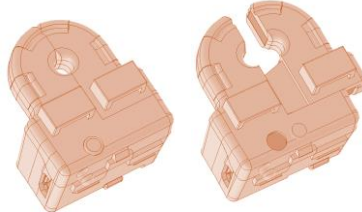

3. Special pliers to position the clamps => keeping the fingers away from the hot wires



4. volTag: Measures voltage on circuit breaker screws

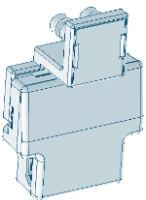

5. Daisy chain to connect the watTags and volTags => no wire tangle mess

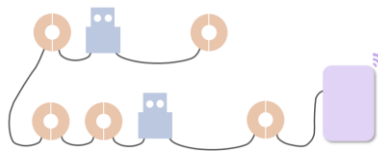

7. Multiple architectures to transfer consumption data

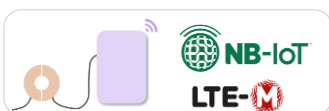
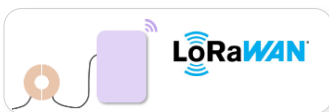

6. Easy configuration, locally and remotely

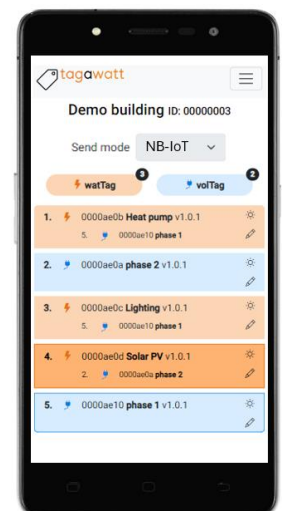

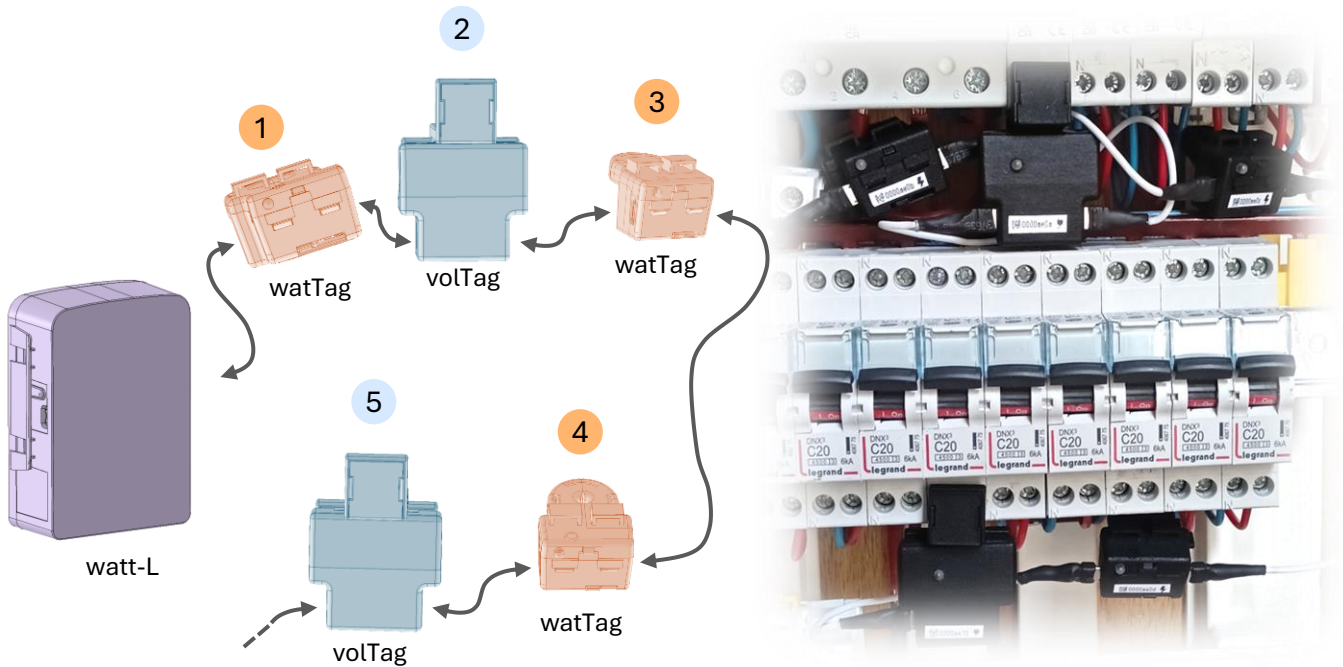

Installation and configuration

watTags and volTags appear in the list whenever you connect them to the daisy-chain

Name a tag whenever you want

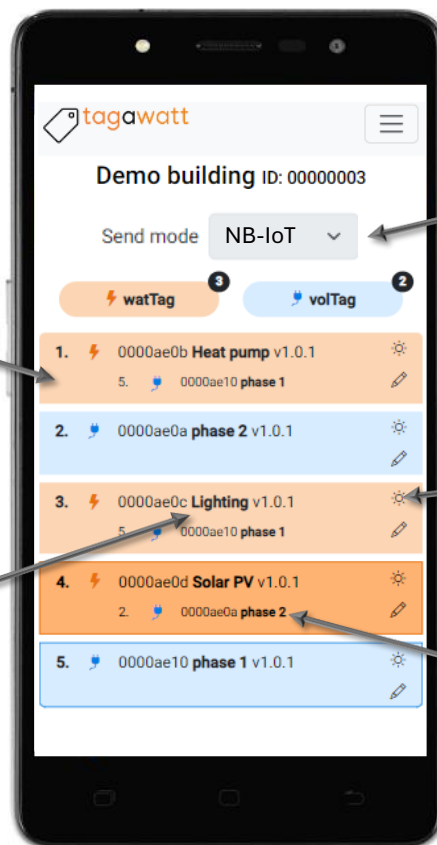

Specify which data collection technology you want to use (NB-IoT, LoRaWAN, LoRa local...)

Make a tag blink to spot it rapidly

Tell a watTag which volTag it should use to calculate the active Power

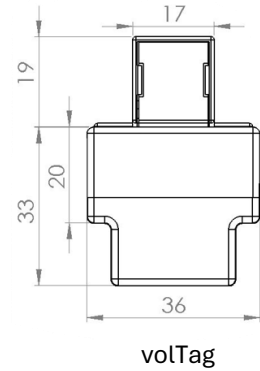
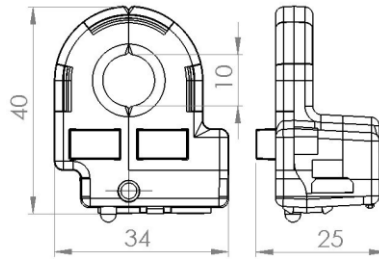
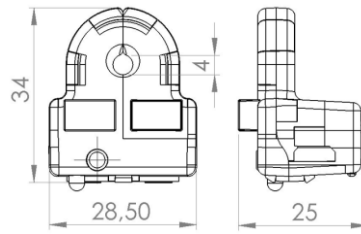
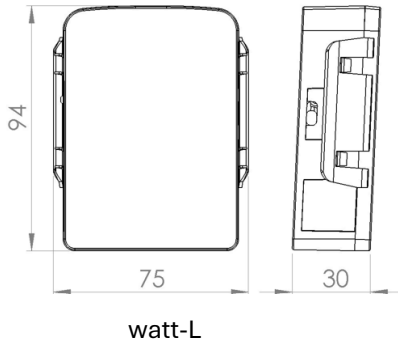

Technical characteristics

Fonction	watTag	Current measurement, active power calculation
	volTag	Voltage measurement
	watt-L	Local and remote configuration Data remote transfer
Measurement	Active power every second	
Available values	Active energy over 1 minute, 10 minutes or 15 minutes (or other configurations)	
Uplink frequency	NB-IoT / LTE-M	Configurable
	LoRaWAN	Same as available values
Configuration	Locally	NB-IoT/LTE-M or special cable for PC/android phone
	Remotely	NB-IoT/LTE-M
Power supply	Mains supply	5V adapter
	Batteries	2 replaceable batteries (3,6V) for temporary supply
Data transfer architectures	NB-IoT/LTE-M	Transmission using the cellular network, replaceable nano SIM
	LoRaWAN	transmission to an operated LoRaWAN Network or a private LoRaWAN gateway
	LoRa local to F-Bridge	LoRa point-to-point transmission to an F-bridge (bridge to NB-IoT/LTE-M)
	LoRa local to F-Link	LoRa point-to-point transmission to an F-Link (bridge to Ethernet, WiFi or MODBUS TCP/IP)